

# SuperQuilt

Multi-layer Insulation Blanket for Roofs, Walls & Floors

e

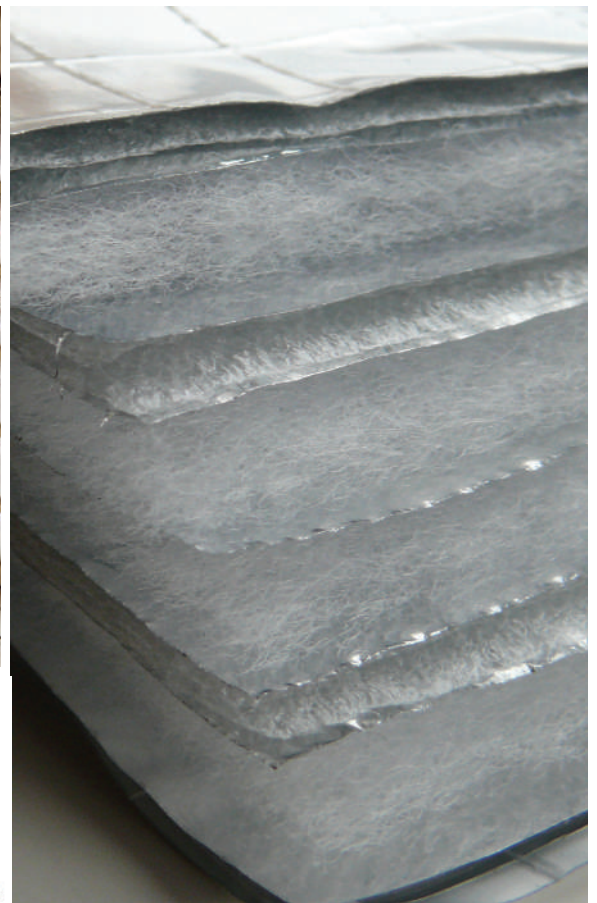

The Highest Performing Certificated MultiFoil on the Market



**Multifoil-Insulation.com**

UK and European Distributors Specialising in  
Multifoil Insulation Solutions

# Insulation for use in Roofs

## Benefits

- NHBC Acceptance
- Meets requirements of L1A and L1B 2010 addition
- In accordance with BR443
- Fully certificated
- Thermally tested in accordance with EN16012
- High thermal resistance of  $2.50\text{m}^2\text{K/W}$
- Effective solar over-heating barrier
- Effective in summer and winter
- Lightweight, thin & flexible
- Fast and simple installation
- Tear Resistant
- For pitched roofs between  $20^\circ$  and  $70^\circ$

SuperQuilt is a very flexible, easy to fit, multilayer insulation thermally tested in accordance with EN16012 achieving a high thermal resistance of  $2.50\text{m}^2\text{K/W}$  for SuperQuilt accompanied by a 25mm air cavity either side of the material.

## How does SuperQuilt Work?

Due to the special composition of multi-layers of insulation, SuperQuilt effectively deals with all forms of energy transfer (i.e. conduction, convection and radiation). SuperQuilt works most effectively by reflecting infra-red radiation. This means that not only is SuperQuilt effective in winter by reflecting heat back into the building and cold out, but also in summer, SuperQuilt is a very effective barrier to solar overheating which reduces the need for artificial cooling systems as it prevents the accumulation of heat within the building.

## General Fixing Instructions

Installation of SuperQuilt for pitched roof applications and additional insulation products should be in accordance with the manufacturers certificate, fixing instructions and current good building practice.

SuperQuilt must be installed with a 50mm overlap with all joints taped with ThermaSeal 75mm foil tape.

SuperQuilt can be cut with a craft knife or a sharp pair of scissors.

SuperQuilt can be easily fixed with staples at regular intervals. Minimum 14mm stainless steel or galvanised staples are recommended.

SuperQuilt is most effective with a minimum 25mm air gap on either side. Battens can be used to create this gap.

No protective clothing/handling required.

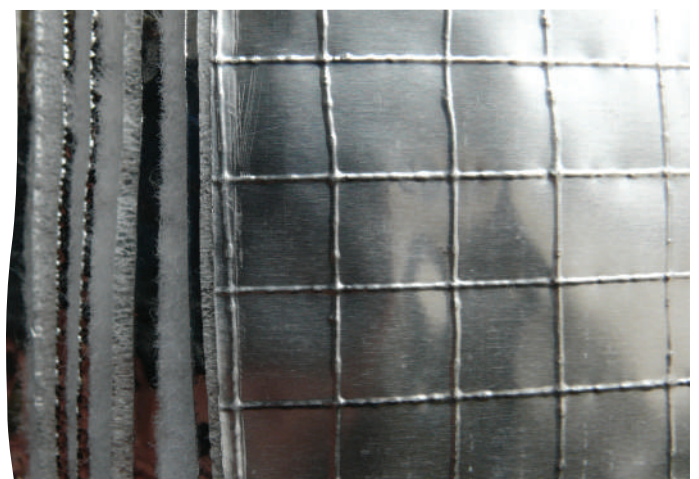

# Under Rafter Pitch Roof

## Fixing Instructions

Installation of SuperQuilt for under rafter applications and additional insulation products should be in accordance with the manufacturers certificate, fixing instructions and current good building practice.

SuperQuilt is applied directly from the roll either vertically or horizontally depending on the rafter height, pulled tight and stapled onto the rafters at minimum 300mm centres.

SuperQuilt should be overlapped at each joint by approx. 50mm and stapled onto the rafters, the joints should be sealed using ThermaSeal Foil Tape. Additionally, at the eaves SuperQuilt is cut around the rafters and sealed to the Cavity wall insulation or wall plate.

Fix 25mm by 38mm battens at right angle to rafters. Battens must always be fixed around the perimeter of windows.

The plasterboard is fixed over the SuperQuilt and onto the battens in the usual manner.

When installed below rafters SuperQuilt will perform as a vapour barrier.

See our How-To Videos please visit [www.multifoil-insulation.com](http://www.multifoil-insulation.com)

U-Value Combined Method (W/m <sup>2</sup> K)			0.18
	Thickness (mm)	Conductivity (W/mK)	Resistance (m <sup>2</sup> K/W)
Outside Surface	-	-	0.040
Slate/Tile	10.00	-	-
Batten Cavity	25.00	-	-
Breather Membrane	-	-	-
Rafter Cavity	30.00	-	0.340
PIR	70.00	0.022	3.182
Rafter Cavity	25.00	-	0.490
SuperQuilt	14.00	-	1.520
Batten Cavity	25.00	-	0.490
Plasterboard	12.50	0.190	0.066
Inside Surface	-	-	0.100
Total Resistance			6.292

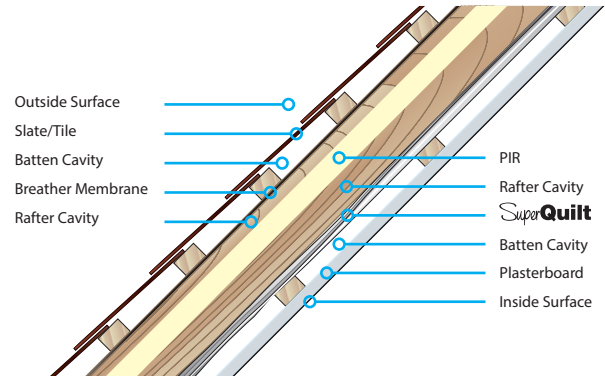

## U-Value table

All calculations are based on 50mm rafters and include the effect of cold bridging. For individual calculation please contact the technical team on 0114 323 0012

### Description (rafters at 400mm centres)

SuperQuilt and 75mm PIR (0.022 W/mk)	0.18 W/m <sup>2</sup> k
SuperQuilt and 130mm Glasswool (0.040 W/mk)	0.18 W/m <sup>2</sup> k
SuperQuilt and 110mm PIR (0.022 W/mk)	0.15 W/m <sup>2</sup> k
SuperQuilt and 140mm PIR (0.022 W/mk)	0.13 W/m <sup>2</sup> k

### Description (rafters at 600mm centres)

SuperQuilt and 70mm PIR (0.022 W/mk)	0.18 W/m <sup>2</sup> k
SuperQuilt and 120mm Glasswool (0.040 W/mk)	0.18 W/m <sup>2</sup> k
SuperQuilt and 95mm PIR (0.022 W/mk)	0.15 W/m <sup>2</sup> k
SuperQuilt and 125mm PIR (0.022 W/mk)	0.13 W/m <sup>2</sup> k

# Over Rafter Pitch Roof

## Fixing Instructions

Installation of SuperQuilt for over rafter applications and additional insulation products should be in accordance with the manufacturers certificate, fixing instructions and current good building practice.

SuperQuilt is applied directly from the roll either vertically or horizontally depending on the rafter height, pulled tight and stapled onto the rafters at minimum 300mm centres.

SuperQuilt should be overlapped at each joint by approx. 50mm and stapled onto the rafters, the joints should be sealed using ThermaSeal Foil Tape. Additionally, at the eaves SuperQuilt is cut around the rafters and sealed to the Cavity wall insulation or wall plate.

Parallel battens, recommended 38mm by 50mm are fixed to the rafters. Battens must always be fixed around the perimeter of windows.

A breather membrane is fitted in accordance with the manufacturers fixing details above the battens before tile battens and tiles. A vapour control layer should be fitted behind plasterboard to prevent any risk of interstitial condensation.

U-Value Combined Method (W/m <sup>2</sup> K)			0.18
	Thickness (mm)	Conductivity (W/mK)	Resistance (m <sup>2</sup> K/W)
Outside Surface	-	-	0.040
Slate/Tile	10.00	-	-
Batten Cavity	25.00	-	-
Breather Membrane	-	-	-
Batten Cavity	38.00	-	0.490
SuperQuilt	14.00	-	1.520
Rafter Cavity	25.00	-	0.490
PIR	70.00	0.022	3.182
Rafter Cavity	40.00	-	0.340
Vapour Control	-	-	-
Plasterboard	12.50	0.190	0.066
Inside Surface	-	-	0.100
Total Resistance			6.292

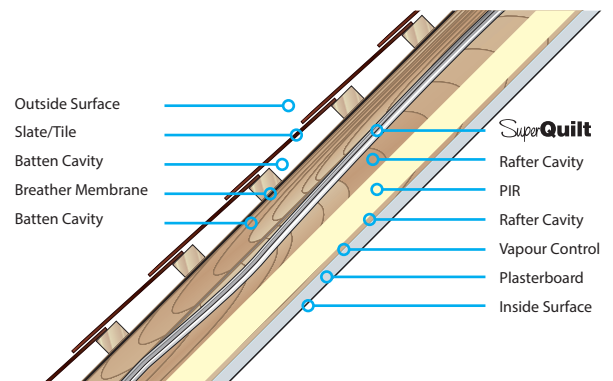

Calculated to include timber bridging

## U-Value table

All calculations are based on 50mm rafters and include the effect of cold bridging. For individual calculation please contact the technical team on 0114 323 0012

### Description (rafters at 400mm centres)

SuperQuilt and 80mm PIR (0.022 W/mk)	0.18 W/m <sup>2</sup> k
SuperQuilt and 135mm Glasswool (0.040 W/mk)	0.18 W/m <sup>2</sup> k
SuperQuilt and 115mm PIR (0.022 W/mk)	0.15 W/m <sup>2</sup> k
SuperQuilt and 145mm PIR (0.022 W/mk)	0.13 W/m <sup>2</sup> k

### Description (rafters at 600mm centres)

Description	U-Value
SuperQuilt and 70mm PIR (0.022 W/mk)	0.18 W/m <sup>2</sup> k
SuperQuilt and 125mm Glasswool (0.040 W/mk)	0.18 W/m <sup>2</sup> k
SuperQuilt and 100mm PIR (0.022 W/mk)	0.15 W/m <sup>2</sup> k
SuperQuilt and 130mm PIR (0.022 W/mk)	0.13 W/m <sup>2</sup> k

# Two Layer Pitch Roof

## Fixing Instructions

Installation of SuperQuilt for under rafter applications and additional insulation products should be in accordance with the manufacturers certificate, fixing instructions and current good building practice.

For recessed installation please see page 12.

For under rafter installation please see page 3 fixing instructions.

When installing two layers of SuperQuilt a 38mm air space should be maintained between layers at all times.

See our How-To Videos at [www.multifoil-insulation.com](http://www.multifoil-insulation.com)

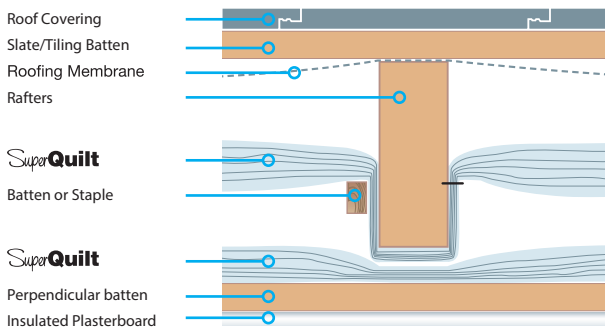

U-Value Combined Method (W/m <sup>2</sup> K)			0.18
	Thickness (mm)	Conductivity (W/mK)	Resistance (m <sup>2</sup> K/W)
Outside Surface	-	-	0.040
Slate/Tile	10.00	-	-
Batten Cavity	25.00	-	-
Roofing Membrane	-	-	-
Rafter Cavity	38.00	-	0.490
SuperQuilt	14.00	-	1.520
Rafter Cavity	38.00	-	0.490
SuperQuilt	14.00	-	1.520
Batten Cavity	25.00	-	0.490
Phenolic Plasterboard	32.50	-	0.630
Inside Surface	-	-	0.100
<b>Total Resistance</b>			<b>5.784</b>

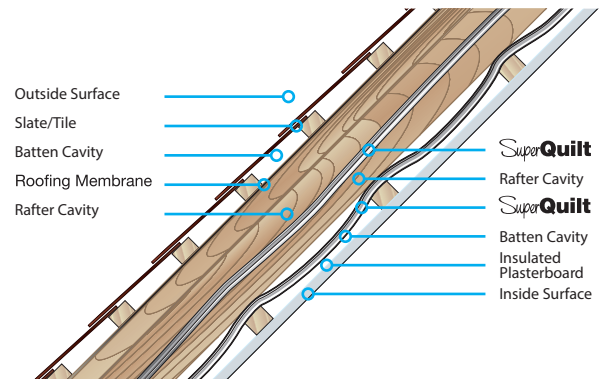

Calculated to include timber bridging

## U-Value table

All calculations are based on 50mm rafters and include the effect of cold bridging. For individual calculation please contact the technical team on 0114 323 0012

### Description (rafters at 400mm centres)

Description	U-Value
SuperQuilt (2 Layers) with 40mm insulated Plasterboard (XPS) (1.070 m <sup>2</sup> K/W)	0.18 W/m <sup>2</sup> k
SuperQuilt (2 Layers) and 50mm PIR (0.022 W/mK)	0.15 W/m <sup>2</sup> k
SuperQuilt (2 Layers) and 57.5mm Insulated Plasterboard (PIR) (2.2 m <sup>2</sup> K/W)	0.15 W/m <sup>2</sup> k
SuperQuilt (2 Layers) and 80mm PIR (0.022 W/mK)	0.13 W/m <sup>2</sup> k

### Description (rafters at 600mm centres)

Description	U-Value
SuperQuilt (2 Layers) with 40mm insulated Plasterboard (XPS) (1.070 m <sup>2</sup> K/W)	0.18 W/m <sup>2</sup> k
SuperQuilt (2 Layers) and 45mm PIR (0.022 W/mK)	0.15 W/m <sup>2</sup> k
SuperQuilt (2 Layers) and 57.5mm Insulated Plasterboard (PIR) (2.2 m <sup>2</sup> K/W)	0.15 W/m <sup>2</sup> k
SuperQuilt (2 Layers) and 70mm PIR (0.022 W/mK)	0.13 W/m <sup>2</sup> k

# Three Layer MultiFoil System



## Fitting Instructions:

BreatherQuilt is stapled directly to the external of the rafters with the reflective aluminium foil facing downwards. Start at the edge of the roof and work horizontally. Tape a line of ThermaSeal Double Sided tape along the top edge of the material. Install the next layer of BreatherQuilt using a 100mm overlap. Once the roof is fully covered install horizontal tile battens. If your rafters are 75mm or less you will need a vertical batten first.

From the internal of the rafters you can now install both layers of SuperQuilt. Recessing the first layer by stapling back into the rafters. Once stapled, fully tape and seal using True Aluminium ThermaSeal Foil Joining Tape.

Once the first layer has been installed, staple a second layer of SuperQuilt directly through the first layer using 14mm staples. Pull this taught across the rafters so an airgap is present.

Fully tape and seal the second layer to ensure the product works as a high performing Vapour Control layer. You can now install 25mm battens before plasterboard finish.

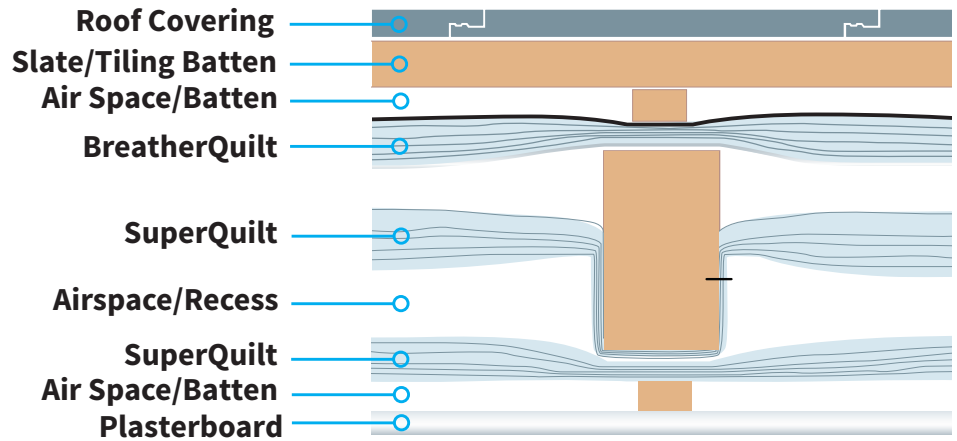

U-Value Combined Method (W/m2K)			0.18
	Thickness (mm)	Conductivity (W/m2K)	Resistance (m2K/W)
Outside Surface	-	-	0.040
Slate/Tile	10.00		
Batten Cavity	25.00		
BreatherQuilt	10.00	1.00	1.100
Rafter Cavity	25.00		0.490
SuperQuilt	14.00		1.520
Rafter Cavity	38.00		0.490
SuperQuilt	14.00		1.520
Batten Cavity	25.00		0.490
Plasterboard	12.50	0.190	0.066
Inside Surface			0.100
<b>Total Resistance</b>			<b>5.784</b>

**No Requirement for Rigid PIR Boards or Mineral Wool!**  
**Can be installed in little as 75mm Rafters!**

**Free Next Working Day Delivery on orders over £100+Vat**

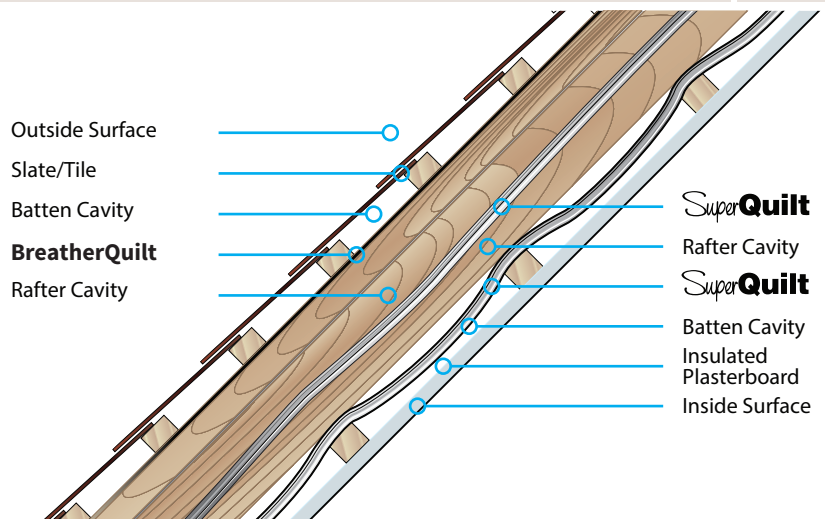

Calculated to include timber bridging

**To Order BreatherQuilt or for anymore Information Visit [MultiFoil-Insulation.com](http://MultiFoil-Insulation.com) Or Call our dedicated team on 0114 323 0012**

# Under Joist Flat Roof

## Fixing Instructions

Installation of SuperQuilt for under joist flat roof applications and additional insulation products should be in accordance with the manufacturers certificate, fixing instructions and current good building practice.

SuperQuilt should be overlapped at each joint by approx. 50mm and stapled onto the joists, the joints should be sealed using ThermaSeal Foil Tape when SuperQuilt is cut to fit around openings or connections, gaps must be minimized and any exposed cut edges should be sealed with YBS Foil Tape to prevent condensation.

SuperQuilt should be cut equal to the width of the roof section plus 100mm. Installation should start from the external wall with SuperQuilt being unrolled perpendicular to the joists, after which it is stapled, nailed or screwed using saddle clips.

SuperQuilt should be held in place using timber battens or by other means as shown, in such a way that there is a nominal 25mm air cavity above the product (if applicable) and a nominal 25mm air cavity below. To minimize the effect of thermal bridging cross battening is advised.

When installed below joists SuperQuilt will perform as a vapour barrier.

U-Value Combined Method (W/m <sup>2</sup> K)			0.18
	Thickness (mm)	Conductivity (W/mK)	Resistance (m <sup>2</sup> K/W)
EPDM	-	-	-
Ply decking	-	-	-
Cavity (ventilated)	50.00	-	0.170
PIR	100.00	0.022	4.545
SuperQuilt	14.00	-	1.520
Batten Cavity	25.00	-	0.490
Plasterboard	12.50	0.190	0.066
Inside Surface	-	-	0.100
Total Resistance			6.891

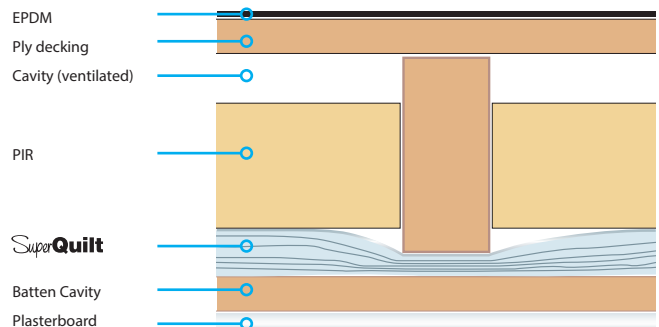

## U-Value table

All calculations are based on 50mm joists and include the effect of cold bridging. For individual calculation please contact the technical team on 0871 917 0044

### Description (rafters at 400mm centres)

SuperQuilt and 160mm Mineral Wool (0.040 W/mk)	0.18 W/m <sup>2</sup> k
SuperQuilt and 140mm Mineral Wool (0.033 W/mk)	0.18 W/m <sup>2</sup> k
SuperQuilt and 180mm Mineral Wool (0.033 W/mk)	0.15 W/m <sup>2</sup> k
SuperQuilt and 100mm PIR (0.022 W/mk)	0.18 W/m <sup>2</sup> k
SuperQuilt and 135mm PIR (0.022 W/mk)	0.15 W/m <sup>2</sup> k
SuperQuilt and 165mm PIR (0.022 W/mk)	0.13 W/m <sup>2</sup> k

### Description (rafters at 600mm centres)

SuperQuilt and 150mm Mineral Wool (0.040 W/mk)	0.18 W/m <sup>2</sup> k
SuperQuilt and 125mm Mineral Wool (0.033 W/mk)	0.18 W/m <sup>2</sup> k
SuperQuilt and 170mm Mineral Wool (0.033 W/mk)	0.15 W/m <sup>2</sup> k
SuperQuilt and 90mm PIR (0.022 W/mk)	0.18 W/m <sup>2</sup> k
SuperQuilt and 120mm PIR (0.022 W/mk)	0.15 W/m <sup>2</sup> k
SuperQuilt and 145mm PIR (0.022 W/mk)	0.13 W/m <sup>2</sup> k

## Under Joist Flat Roof

### Fixing Instructions

Installation of SuperQuilt for under joist flat roof applications and additional insulation products should be in accordance with the manufacturers certificate, fixing instructions and current good building practice.

SuperQuilt should be overlapped at each joint by approx. 50mm and stapled onto the joists, the joints should be sealed using ThermaSeal Foil Tape when SuperQuilt is cut to fit around openings or connections, gaps must be minimized and any exposed cut edges should be sealed with YBS Foil Tape to prevent condensation.

SuperQuilt should be cut equal to the width of the roof section plus 100mm. Installation should start from the external wall with SuperQuilt being unrolled perpendicular to the rafters, after which it is fixed using staples, nails or saddle clips.

SuperQuilt should be held in place using timber battens or by other means as shown, in such a way that there is a nominal 25mm air cavity above the product (if applicable) and a nominal 25mm air cavity below. To minimize the effect of thermal bridging cross battening is advised.

When installed below joists SuperQuilt will perform as a vapour barrier.

U-Value Combined Method (W/m <sup>2</sup> K)			0.18
	Thickness (mm)	Conductivity (W/mK)	Resistance (m <sup>2</sup> K/W)
EPDM	-	-	-
Ply decking	-	-	-
Cavity (ventilated)	50.00	-	0.170
PIR	90.00	0.022	4.091
Cavity (non-ventilated)	25.00	-	0.490
SuperQuilt	14.00	-	1.520
Batten Cavity	25.00	-	0.490
Plasterboard	12.50	-	0.066
Inside Surface	-	-	0.100
Total Resistance			6.927

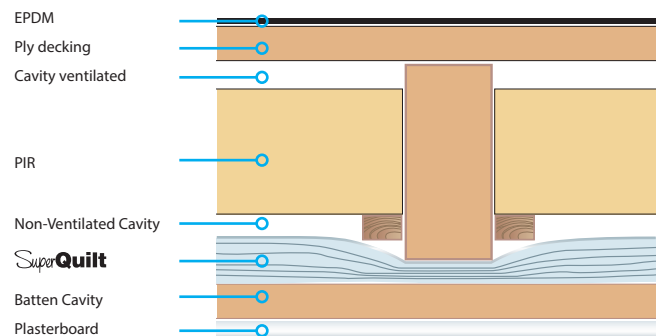

### U-Value table

All calculations are based on 50mm joists and include the effect of cold bridging. For individual calculation please contact the technical team on 0114 323 0012

#### Description (rafters at 400mm centres)

SuperQuilt and 140mm Mineral Wool (0.040 W/mk)	0.18 W/m <sup>2</sup> k
SuperQuilt and 120mm Mineral Wool (0.033 W/mk)	0.18 W/m <sup>2</sup> k
SuperQuilt and 170mm Mineral Wool (0.033 W/mk)	0.15 W/m <sup>2</sup> k
SuperQuilt and 90mm PIR (0.022 W/mk)	0.18 W/m <sup>2</sup> k
SuperQuilt and 120mm PIR (0.022 W/mk)	0.15 W/m <sup>2</sup> k
SuperQuilt and 150mm PIR (0.022 W/mk)	0.13 W/m <sup>2</sup> k

#### Description (rafters at 600mm centres)

SuperQuilt and 130mm Mineral Wool (0.040 W/mk)	0.18 W/m <sup>2</sup> k
SuperQuilt and 110mm Mineral Wool (0.033 W/mk)	0.18 W/m <sup>2</sup> k
SuperQuilt and 150mm Mineral Wool (0.033 W/mk)	0.15 W/m <sup>2</sup> k
SuperQuilt and 80mm PIR (0.022 W/mk)	0.18 W/m <sup>2</sup> k
SuperQuilt and 110mm PIR (0.022 W/mk)	0.15 W/m <sup>2</sup> k
SuperQuilt and 135mm PIR (0.022 W/mk)	0.13 W/m <sup>2</sup> k



## Over Joist Flat Roof

### Fixing Instructions

Installation of SuperQuilt for over joist flat roof applications and additional insulation products should be in accordance with the manufacturers certificate, fixing instructions and current good building practice.

SuperQuilt should be overlapped at each joint by approx. 50mm and stapled onto the joists, the joints should be sealed using ThermaSeal Foil Tape when SuperQuilt is cut to fit around openings or connections, gaps must be minimized and any exposed cut edges should be sealed with YBS Foil Tape to prevent condensation.

SuperQuilt should be cut equal to the width of the roof section plus 100mm. Installation should start from the external wall with SuperQuilt being unrolled perpendicular to the rafters, after which it is fixed using staples or nails or with saddle clips.

SuperQuilt should be held in place using timber battens or by other means as shown, in such a way that there is a nominal 25mm air cavity above the product (if applicable) and a nominal 25mm air cavity below. To minimize the effect of thermal bridging cross battening is advised.

Additional insulation should be installed above the SuperQuilt.

When installed below rafters SuperQuilt will perform as a vapour barrier.

### U-Value table

All calculations are based on 50mm joists and include the effect of cold bridging. For individual calculation please contact the technical team on 0114 323 0012

U-Value Combined Method (W/m <sup>2</sup> K)			0.18
	Thickness (mm)	Conductivity (W/mK)	Resistance (m <sup>2</sup> K/W)
EPDM	-	-	0.040
PIR	65.00	0.022	2.955
Ply decking	18.00	0.130	0.138
Non-Ventilated Cavity	25.00	-	0.490
SuperQuilt	14.00	-	1.520
Non-Ventilated Cavity	75.00	-	0.490
Plasterboard	12.50	0.190	0.066
Inside Surface	-	-	0.100
Total Resistance			5.799

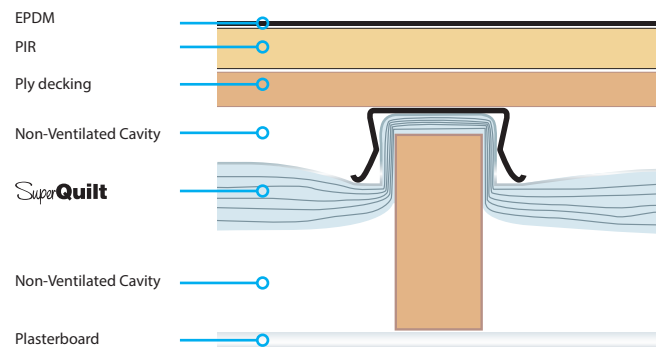

#### Description (rafters at 400mm centres)

SuperQuilt and 65mm PIR (0.022 W/mk)

#### U-Value

0.18 W/m <sup>2</sup>k

SuperQuilt and 90mm PIR (0.022 W/mk)

0.15 W/m <sup>2</sup>k

SuperQuilt and 105mm PIR (0.022 W/mk)

0.13 W/m <sup>2</sup>k

SuperQuilt and 85mm XPS (0.029 W/mk)

0.18 W/m <sup>2</sup>k

SuperQuilt and 120mm XPS (0.029 W/mk)

0.15 W/m <sup>2</sup>k

SuperQuilt and 140mm XPS (0.029 W/mk)

0.13 W/m <sup>2</sup>k

#### Description (rafters at 600mm centres)

#### U-Value

SuperQuilt and 65mm PIR (0.022 W/mk)

0.18 W/m <sup>2</sup>k

SuperQuilt and 90mm PIR (0.022 W/mk)

0.15 W/m <sup>2</sup>k

SuperQuilt and 105mm PIR (0.022 W/mk)

0.15 W/m <sup>2</sup>k

SuperQuilt and 85mm XPS (0.029 W/mk)

0.18 W/m <sup>2</sup>k

SuperQuilt and 120mm XPS (0.029 W/mk)

0.15 W/m <sup>2</sup>k

SuperQuilt and 135mm XPS (0.029 W/mk)

0.13 W/m <sup>2</sup>k

## Two Layer Flat Roof

### Fixing Instructions

Installation of SuperQuilt for over and under rafter flat roof applications with additional insulation should be in accordance with the manufacturers certificate, fixing instructions and current good building practice.

SuperQuilt should be overlapped at each joint by approx. 50mm and stapled onto the rafters, the joints should be using ThermaSeal Foil Tape when SuperQuilt is cut to fit around openings or connections, gaps must be minimized and any exposed cut edges should be sealed with YBS Foil Tape to prevent condensation.

SuperQuilt should be cut equal to the width of the roof section plus 100mm. Installation should start from the external wall with SuperQuilt being unrolled perpendicular to the joists after which it is fixed using staples, nails or saddle clips.

SuperQuilt should be held in place using timber battens or by other means as shown, in such a way that there is a nominal 25mm air cavity above the product (if applicable) and a nominal 25mm air cavity below. To minimize the effect of thermal bridging cross battening is advised.

When installed below joists SuperQuilt will perform as a vapour barrier.

U-Value Combined Method (W/m <sup>2</sup> K)			0.18
	Thickness (mm)	Conductivity (W/mK)	Resistance (m <sup>2</sup> K/W)
EPDM	-	-	0.040
Ply decking	18.00	0.130	0.138
Non-Ventilated Cavity	25.00	-	0.490
SuperQuilt	14.00	-	1.520
Non-Ventilated Cavity	25.00	-	0.490
PIR	25.00	0.022	1.136
SuperQuilt	14.00	-	1.520
Batten Cavity	25.00	-	0.490
Plasterboard	12.50	0.190	0.066
Inside Surface	-	-	0.100
Total Resistance			5.990

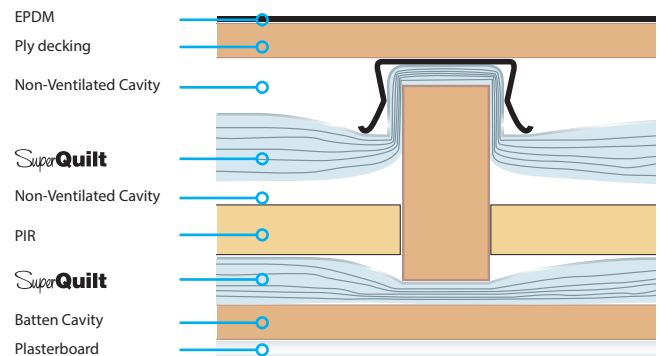

### U-Value table

All calculations are based on 50mm joists and include the effect of cold bridging. For individual calculation please contact the technical team on 0114 323 0012

#### Description (rafters at 400mm centres)

SuperQuilt and 50mm Mineral Wool (0.040 W/mk)	0.18 W/m <sup>2</sup> k
SuperQuilt and 100mm Mineral Wool (0.040 W/mk)	0.15 W/m <sup>2</sup> k
SuperQuilt and 40mm Mineral Wool (0.033 W/mk)	0.18 W/m <sup>2</sup> k
SuperQuilt and 30mm PIR (0.022 W/mk)	0.18 W/m <sup>2</sup> k
SuperQuilt and 65mm PIR (0.022 W/mk)	0.15 W/m <sup>2</sup> k
SuperQuilt and 75mm PIR (0.022 W/mk)	0.13 W/m <sup>2</sup> k

#### Description (rafters at 600mm centres)

SuperQuilt and 50mm Mineral Wool (0.040 W/mk)	0.18 W/m <sup>2</sup> k
SuperQuilt and 90mm Mineral Wool (0.040 W/mk)	0.15 W/m <sup>2</sup> k
SuperQuilt and 40mm Mineral Wool (0.033 W/mk)	0.18 W/m <sup>2</sup> k
SuperQuilt and 25mm PIR (0.022 W/mk)	0.18 W/m <sup>2</sup> k
SuperQuilt and 55mm PIR (0.022 W/mk)	0.15 W/m <sup>2</sup> k
SuperQuilt and 65mm PIR (0.022 W/mk)	0.13 W/m <sup>2</sup> k

## Recessed Detail

### Over Rafter Application

Where roof height is critical SuperQuilt can be recessed between the rafters.

1. SuperQuilt is stapled to the top of the first rafter.
2. SuperQuilt is recessed into the rafter void and fixed with staples or with battens.
3. The material is then fixed to opposite rafter as per instruction 2.
4. SuperQuilt is then wrapped around the rafter and the procedure starts again.

Once all the SuperQuilt is fitted, all joints should be taped using ThermaSeal Foil Tape.

A breather membrane is then fitted in accordance with the manufacturers fitting instructions.

Tile batten and tiles can then be fitted.

### Under Rafter Application

Ensure that there is an airspace above the SuperQuilt at all times.

1. SuperQuilt is stapled to the underside of the first rafter.
2. SuperQuilt is recessed into the rafter void and fixed with staples or with battens.
3. The material is then fixed to opposite rafter as per instruction 2.
4. SuperQuilt is then wrapped around the rafter and the procedure starts again.

Once all the SuperQuilt is fitted, all joints should be taped using ThermaSeal Foil tape.

Plasterboard can then be fixed directly to the underside of the rafters below the SuperQuilt.

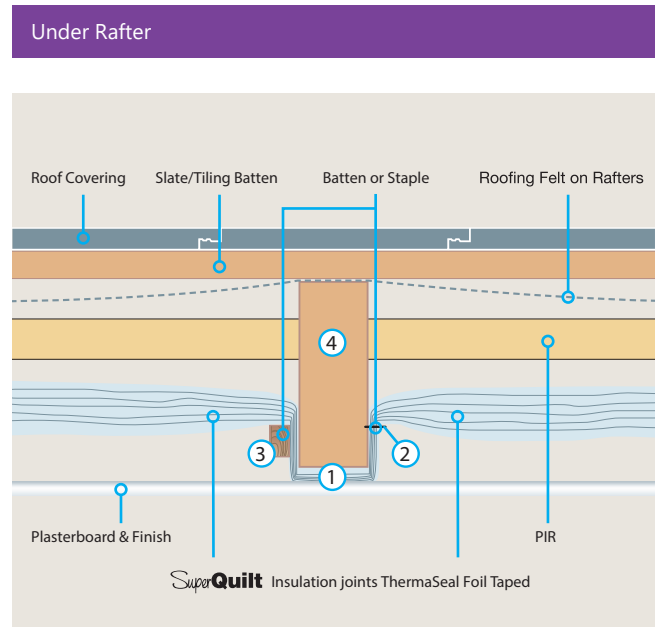
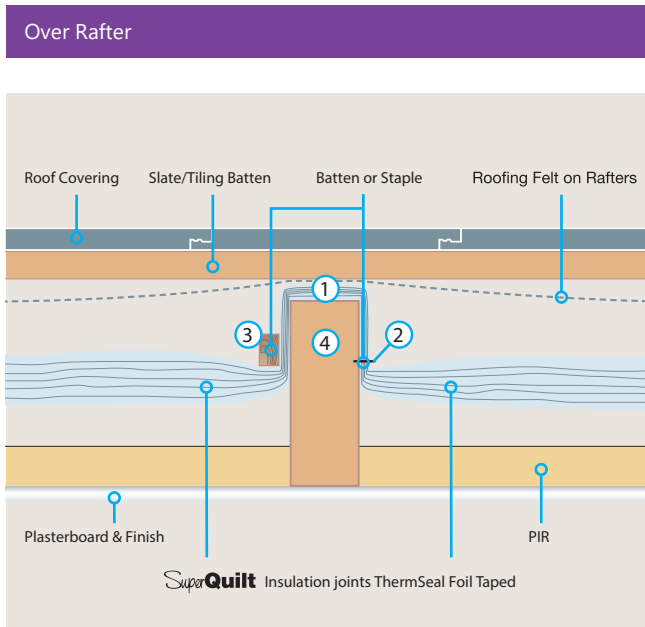

To see an easy way to recess SuperQuilt, please see our [How-To Video \(Superquilt Double Layer\)](http://www.multifoil-insulation.com) at [www.multifoil-insulation.com](http://www.multifoil-insulation.com)

Call us on 0114 323 0012 for more Technical Information or to Order

## Purlin Details

### Between Purlins Application

SuperQuilt is fixed horizontally or vertically and stapled to the underside of the the rafters.

At the purlins the SuperQuilt is turned up and stapled in place.

Perpendicular Battens are fixed through the SuperQuilt into the rafters, at the purlins the battens are fixed into the rafters crushing the SuperQuilt tightly against the purlins.

Plasterboard can then be fixed to the battens.

### Around Purlins Application

SuperQuilt is fixed horizontally or vertically and stapled to the underside of the the rafters.

At the purlins the SuperQuilt is cut and pushed behind the purlins then taped to the next piece at the opposite side of the purlin.

Perpendicular Battens are fixed through the SuperQuilt into the rafters.

Plasterboard can then be fixed to the battens.

### Between Purlins

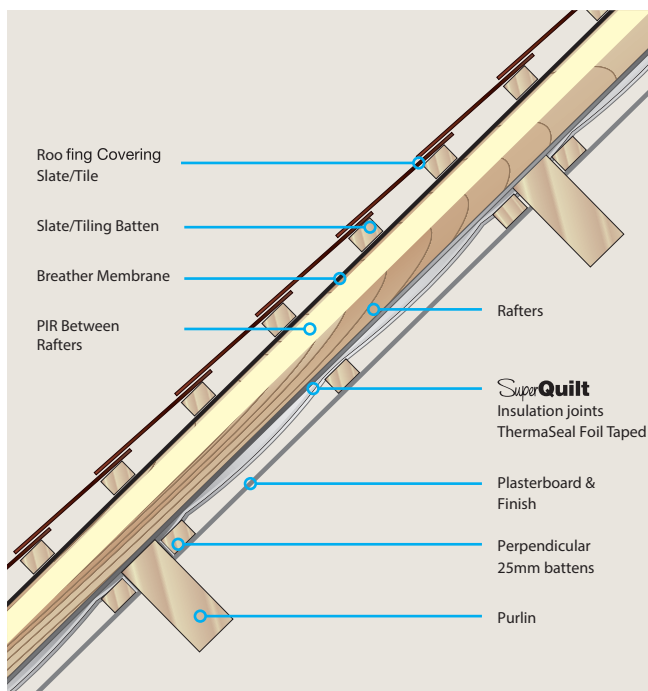

### Around Purlins

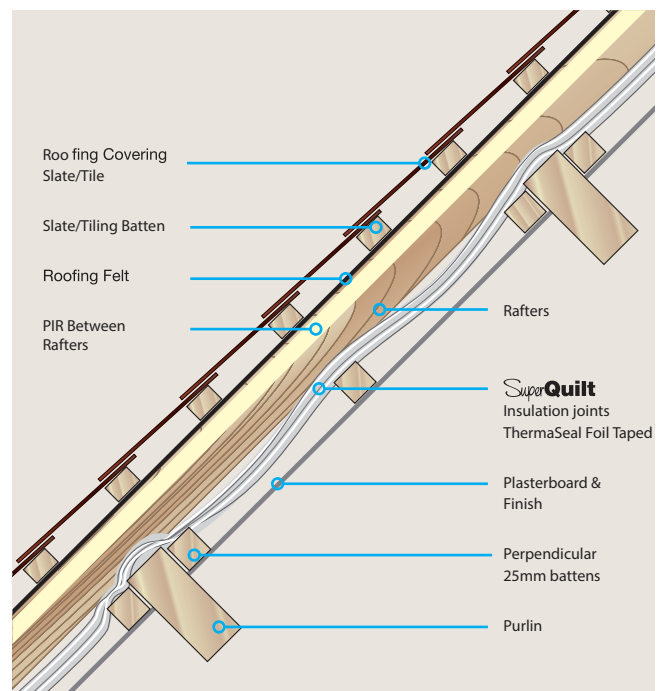

# Detailing

## Vents / Light Pipes

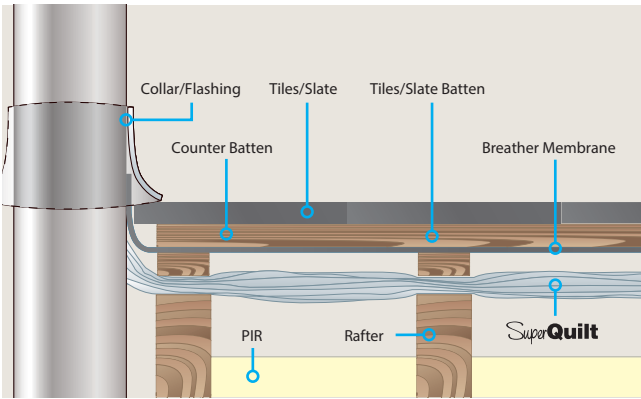

## Fixing Instructions

SuperQuilt is fixed above rafters as per fixing details and turned up at the vent/wall/rooflight and sealed with ThermaSeal Foil Tape. Battens are placed on the rafters above the SuperQuilt. A breather membrane is fixed above the battens and finished by turning up at the vent/wall/rooflight and sealing to the vent/wall/rooflight. Tile battens are fixed in place. The flashing/collar for the vent/wall/rooflight is fitted above the tile battens and then tiles.

## Flashing

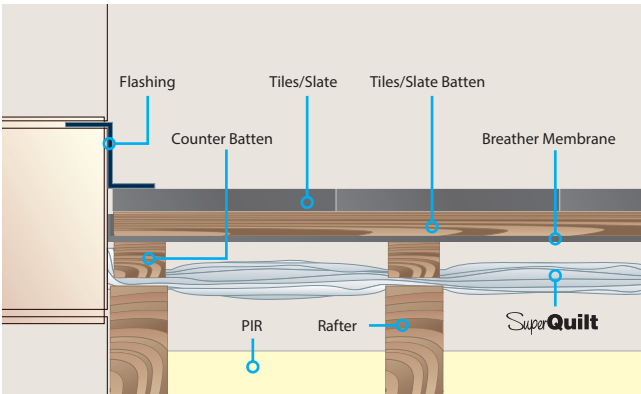

## Rooflight

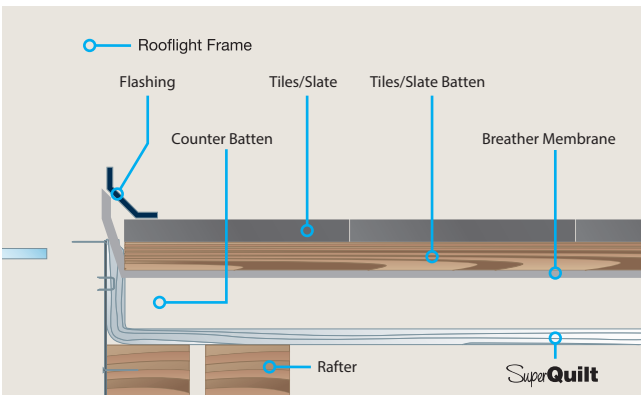

# Detailing

## Over Rafter Fixing Details

SuperQuilt is stapled to the rafters. At the eaves the SuperQuilt is cut and taken down between the rafters to the cavity wall insulation or the wall plate. The SuperQuilt needs to be sealed with staples and taped to the rafters and the cavity wall insulation or wall plate to create an airtight envelope.

## Under Rafter Fixing Details

SuperQuilt is stapled to the underside of the rafters. At the eaves the SuperQuilt is cut and taken down between the joists to the cavity wall insulation or the wall plate. The material needs to be fixed to the rafters with minimum 14mm staples and taped to the joists and cavity wall insulation or wall plate so that an airtight envelope is created.

## ThermaSeal Foil taped joints

SuperQuilt should be overlapped at each joint by approx. 50mm and stapled onto the battens, the joints should be sealed using Genuine ThermaSeal 75mm Foil Tape.

## Vapour control layer

When all joints are sealed using ThermaSeal foil tape SuperQuilt also works as a vapour control layer.

## Fitting Equipment

At MultiFoil-Insulation.com we supply a range of fitting equipment such as Genuine ThermaSeal Foil Tape, Double Sided Tape, Pipe and Saddle Clips, Staple Gun Kits, Knives and Scissors. Ideal for all Multifoil installation projects.

### Eaves

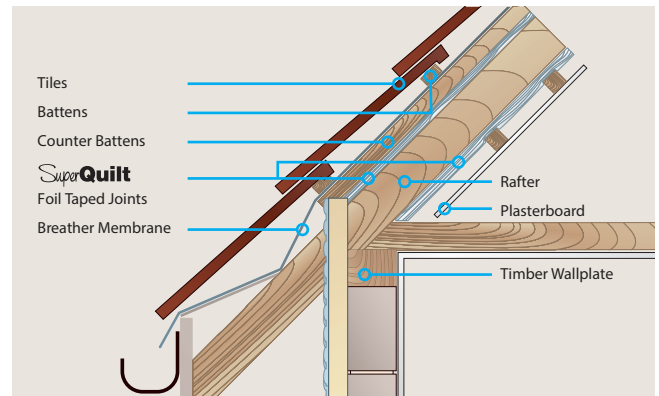

### Valleys

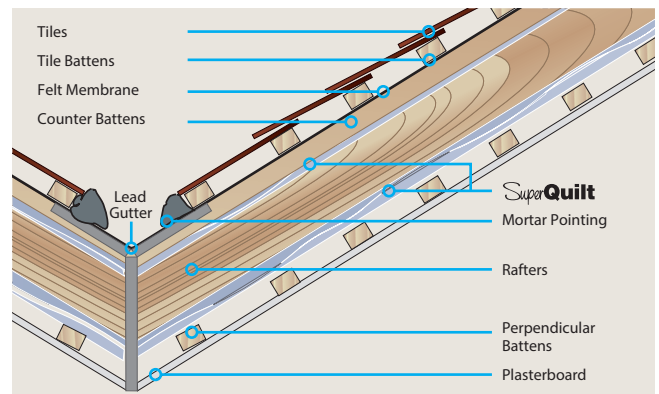

### Downlighters

We Recommend using Fire Hoods when installing downlighters

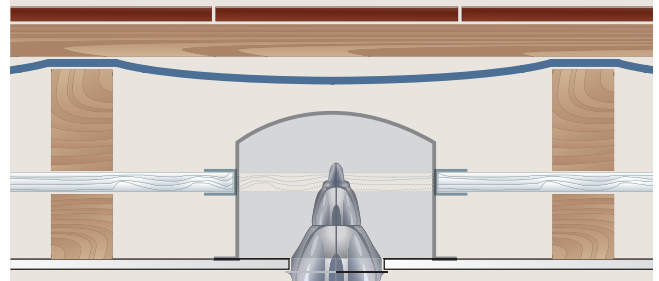

A circular hole is cut in the SuperQuilt to create a minimum 25mm clearance from the downlighter. The cut edge must be completely sealed using ThermaSeal Foil Tape.



MultiFoil-Insulation.com have a range of How-To Videos.  
 We also have Data Sheets for Walls and Floors.  
 For more Technical Information Please call us  
 on 0114 323 0012.

### Technical Properties

Product Description		
19 Components		
Thickness	40mm appr ox.	
Weight	800g/m <sup>2</sup>	
Mechanical Properties	Value	Refer ence Standard
Thermal performance		
Core	1.52m <sup>2</sup> K/W	BS EN 16012
Roof	2.50m <sup>2</sup> K/W	BS EN 6946
Wall	3.00m <sup>2</sup> K/W	BS EN 6946
Floor	4.45m <sup>2</sup> K/W	BS EN 6946
Flammability	Class E	BS EN 13501-1
Water vapour resistance	1569MNs/g	BS EN 12572
Emission coefficients of surfaces	0.02	BS EN 16012
Tensile strength	142KP A	BS EN 1608
Packaging	15m <sup>2</sup>	7.5m <sup>2</sup>
Width	1.5m	1.5m
Length	10m	5m
Weight	12.5Kg	6.25Kg

# MultiFoil-Insulation.com

UK and European Distributors Specialising in  
 MultiFoil Insulation Solutions

Tel: 0114 323 0012 Email: [sales@multifoil-Insulation.com](mailto:sales@multifoil-Insulation.com)

**Try our Free and Easy To Use Online U-Value Calculator!**